

THIS DOCUMENT IS THE PROPERTY OF KEYSTONE ELECTRONICS CORP. AND SHALL NOT BE REPRODUCED, DISTRIBUTED OR USED AS A BASIS FOR MANUFACTURE WITHOUT PRIOR WRITTEN PERMISSION FROM KEYSTONE ELECTRONICS CORP.

ACTUAL SIZE

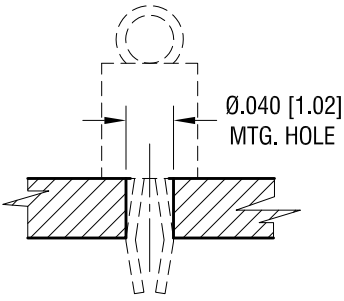

MTG. DETAIL



Ø.040 [1.02]
MTG. HOLE

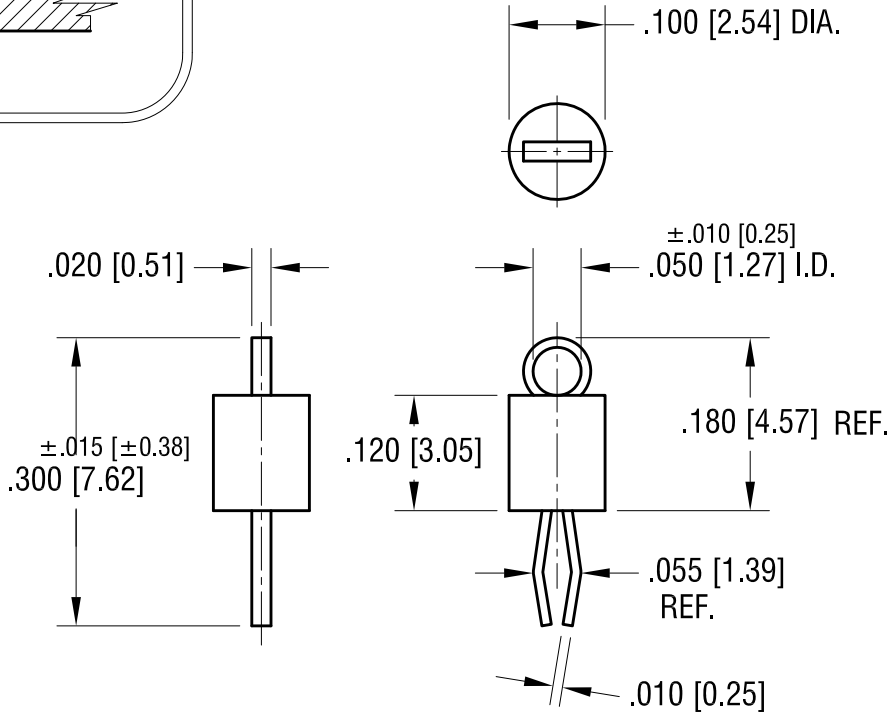

PART NO.	BASE COLOR
5000	RED
5001	BLACK
5002	WHITE
5003	ORANGE
5004	YELLOW

NOTES:

1. TERMINAL:

MAT'L - PHOSPHOR BRONZE WIRE

BASE:

MAT'S - HEAT RESISTANT NYLON 46

DATE	DESCRIPTION	REV.
12.30.13	CHANGE AS PER ECN 13-119	H
12.04.08	CHANGE AS PER ECN 08-184	G
6.09.08	CHANGE AS PER ECN 08-108	F
8.17.06	CHANGE AS PER ECN 06-043	E
1.23.06	CHANGE AS PER ECN 06-007	D

KEYSTONE ELECTRONICS CORP.			
www.keyelco.com • ASTORIA, N.Y. 11105-2017 • Tel (718) 956-8900			
PART NAME			
PC TEST POINT - MINIATURE			
MATERIAL			
AS NOTED			
FINISH		DRN BY	DATE
SILVER PLATE		BOONE	6.19.95
		APP'D	SCALE
		LN	5X
TOLERANCES	INCH [MM]	CODE	DWG NO.
DECIMAL	± .005 [± 0.15]	C	5000-5004
ANGULAR	± 1°		
UNLESS OTHERWISE SPECIFIED			

Mouser Electronics

Authorized Distributor

Click to View Pricing, Inventory, Delivery & Lifecycle Information:

[Keystone Electronics:](#)

[5000](#)